



# ACCESS OPTIONS

FOR PATIENTS WITH  
VENOUS OUTFLOW  
INSUFFICIENCY

**-HERO<sup>®</sup>**  
GRAFT

SYSTEM

MERIT IS COMMITTED  
TO DIALYSIS ACCESS



SYSTEM

When end stage renal disease patients are catheter-dependent or are approaching catheter dependency, the HeRO Graft (Hemodialysis Reliable OutFlow) is the ONLY fully subcutaneous AV access solution clinically proven to maintain long-term access for hemodialysis patients with central venous stenosis. The HeRO Graft may be an option for patients with failing fistulas or grafts due to poor venous outflow as determined by access failure or venography.

Unlike a stent, HeRO Graft’s Venous Outflow Component (VOC) can be removed and replaced if necessary.

**Benefits of the HeRO Graft**

**FEWER INFECTIONS**

**69% reduced** infection rate compared with catheters<sup>1</sup>

**SUPERIOR DIALYSIS ADEQUACY**

1.6–1.7 Kt/V, a **10% to 44% improvement** compared with catheters<sup>1,4</sup>

**HIGH PATENCY RATES**

Up to **87% cumulative patency** at two years<sup>1,2</sup>

**COST SAVINGS**

A **23% average savings** per year compared with catheters predicted by a US healthcare model for provision of dialysis access<sup>3</sup>

**IS YOUR PATIENT A CANDIDATE FOR THE HERO GRAFT?**

- Is the patient failing an AVF or AVG?
- Is the measured Kt/V less than 1.4?
- Has the flow rate dropped >20%?
- Is the patient catheter dependent or approaching catheter dependency?
- Does the patient have swollen arms and/or distended collateral veins?

If **YES** is answered for any of the questions above, consider referring patient for a central bilateral venogram for assessment of central venous stenosis.

**CLINICAL OUTCOMES**

	<b>HeRO Graft</b> Gage, et al. EJVES <sup>2</sup>	<b>HeRO Graft</b> Nassar, et al Semin Dial <sup>4</sup>	<b>HeRO Graft</b> Katzman, et al. JVS <sup>1</sup>	<b>Catheter Literature</b> <sup>1</sup>	<b>ePTFE Graft Literature</b> <sup>1</sup>
Device/Procedure-Related Bacteremia Rate/1,000 Days <sup>1</sup>	0.14	0.72	0.70	2.3	0.11 <sup>4</sup>
Adequacy of Dialysis (mean Kt/V) <sup>3</sup>	N/A	1.6	1.7	1.18–1.46	1.37–1.62
Cumulative Patency (at 1 year)	91%	68%	72% <sup>‡</sup>	37%	65%
Intervention Rate (per year)	1.5	2.2	2.5	5.8	1.6–2.4

§ Note: Every 0.1 decrease in Kt/V is estimated to increase the mortality rate by 7%<sup>5</sup> and is significantly (P<0.05) associated with 11% more hospitalizations, 12% more hospital days, and a \$940 increase in Medicare inpatient expenditures.<sup>6</sup>

‡ 8.6 months

<sup>1</sup> Procedure-related bacteremia was defined as any bacteremia seeded by the subject’s previous tunneled dialysis catheter (cultured at the time of HeRO Graft implant), any bacteremia that may have been seeded by a pre-existing infection elsewhere in the subject’s body possibly making the subject more susceptible to bacteremia in the peri-operative period, or where there is no other source for the bacteremia identified other than the implant procedure. Bacteremia was categorized as device-related when no other source for the infection could be identified.

# COMPONENTS OF THE HERO® GRAFT

## ePTFE ARTERIAL GRAFT COMPONENT (HERO1002)

**ORIENTATION LINE ON GRAFT**  
to guide placement during tunneling

6 mm ID x 50 cm

**BEADING (3–4 cm)**  
for kink resistance

3 cm

## VENOUS OUTFLOW COMPONENT (HERO1001VOC)

- No venous anastomosis
- Removable and replaceable

**REINFORCED 48-BRAID NITINOL**  
kink & crush resistant

**RADIOPAQUE  
MARKER BAND  
(1 mm)**  
integrated within the  
silicone at the distal tip

6.3 mm/19F OD  
5 mm ID  
40 cm customizable length

## ACCESSORY COMPONENT KIT (HERO1003)

Instruments and accessories to aid in the placement or revision of a HeRO system.

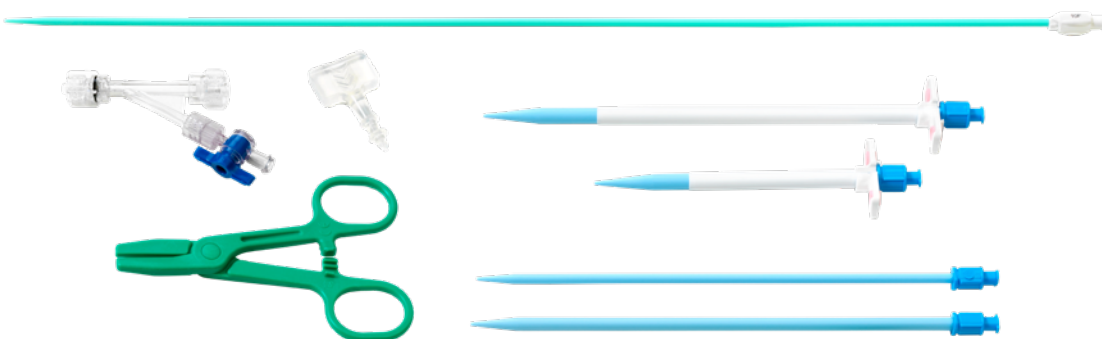

- 10F Delivery Stylet
- 20F peel away sheath with dilator (long and short options)
- Y-adapter with 1-way stopcock
- Hemostasis Plug
- Vascular Clamp
- 12F and 16F Dilators

# HERO® GRAFT SYSTEM CONFIGURATIONS



Allows surgeons to utilize other standard wall and early cannulation vascular grafts.

**HERO1000 Includes:** Adapter, Support Seal, Graft Expander, Venous Outflow Component, Accessory Component Kit

## Early Cannulation Grafts

Flixene® Standard Wall and Gore® Acuseal are qualified for use with the Adapter (**Support Seal not needed**).



## Standard Wall Grafts

Impra®, Gore-Tex®, Gor-Tex® Stretch, and Gore® Propaten® are qualified for use with the Adapter and Support Seal.



**The Adapter has undergone successful in vitro testing with specific vascular grafts (see tables on next page).**



Allows surgeons to revise an existing HeRO Graft.

**HERO1006 Includes:** Adapter, Support Seal, Graft Expander, Vascular Clamp, Syringe

## ADAPTER, SUPPORT SEAL, & GRAFT EXPANDER

- Titanium Adapter connects VOC to other manufacturer grafts
- The Support Seal provides seal reinforcement and kink resistance.
- The Graft Expander aids in expanding a 6 mm ID vascular graft for connection to the Adapter.



Support Seal



Graft Expander

Inflow Graft End  
6 mm ID

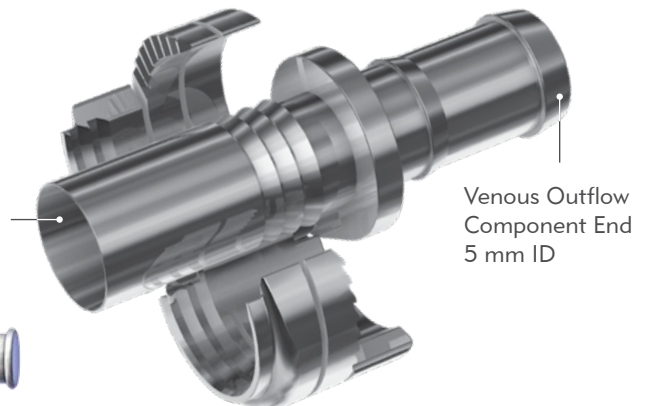

Venous Outflow  
Component End  
5 mm ID

## APPROVED EARLY CANNULATION\* VASCULAR GRAFTS



**Table 1: Marketed 6 mm ID** (qualified for use with the Adapter, Support Seal not needed)

Trade Name	Manufacturer	Catalog Number**	Support Seal Required for HeRO® Graft Adapter
FLIXENE® Standard Wall	Atrium Medical Corp.	25053   25142   25052	NO
GORE® ACUSEAL	W.L. Gore & Associates	ECH060010A   ECH060020A   ECH060040A   ECH060050A.	NO

## APPROVED STANDARD WALL\* VASCULAR GRAFTS



**Table 2: Marketed 6 mm ID** (qualified for use with the Adapter *and* Support Seal)

Trade Name	Manufacturer	Catalog Number**	Support Seal Required for HeRO Graft Adapter
IMPRA®	C.R. Bard	05S06   10S06   20S06   30S06   40S06   50S06 60S06   70S06   80S06   90S06	YES
GORE-TEX®	W.L. Gore & Associates	V06010L   V06020L   V06030L   V06040L V06050L   V06070L   V06080L	YES
GORE-TEX® Stretch	W.L. Gore & Associates	S0601   S0602   S0603   S0604   S0605 S0607   S0608   S0609	YES
GORE® PROPATEN®	W.L. Gore & Associates	H060010A   H060040A   H060060A   H060080A	YES

The Adapter should NOT be connected to any graft other than a new graft listed in Tables 1 and 2.









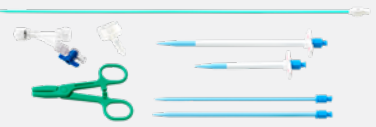

\* Refer to graft manufacturer Instructions for Use or website for indications and further information.

\*\*Catalog numbers may contain identifiers that are not reflected on this table. Consult the graft manufacturer's website to determine which equivalent catalog numbers are available in your region.

# COMMITTED TO DIALYSIS ACCESS

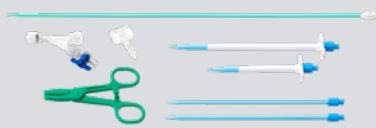
Merit Medical has a broad offering of dialysis access products, including hemodialysis and peritoneal dialysis catheters, balloons, and the HeRO graft. Contact your Merit Sales Professional or visit [Merit.com/DialysisAccess](https://www.Merit.com/DialysisAccess) to learn more about our products and our renowned physician training course, ThinkDialysisAccess.

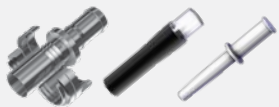
HERO GRAFT SYSTEM ORDERING INFORMATION

Product	Product Code	Components
	HERO1000 (SUPER HERO)	 +  + 
	HERO1001VOC	
	HERO1002	
	HERO1003 (ACCESSORY COMPONENT KIT)	
	HERO1006 (HERO ALLY REVISION KIT)	 + 

- References:
1. Katzman et al., J Vasc Surg 2009.
  2. Gage et al., EJVES 2012.
  3. Dageforde et al., JSR 2012.
  4. Nassar et al., Semin Dial 2014.
  5. Dhingra et al., Kidney Int 2001.
  6. 2006 NKF KDOQI, Guideline 4.

All trademarks and registered trademarks are the property of their respective owners.

Before using refer to Instructions for Use for indications, contraindications, warnings, precautions, and directions for use.



Understand. Innovate. Deliver.™

merit.com

Merit Medical Systems, Inc.  
1600 West Merit Parkway  
South Jordan, Utah 84095  
1.801.253.1600  
1.800.35.MERIT

Merit Medical Europe, Middle East, & Africa (EMEA)  
Amerikalaan 42, 6199 AE  
Maastricht-Airport  
The Netherlands  
+31 43 358 82 22

Merit Medical Ireland Ltd.  
Parkmore Business Park West  
Galway, Ireland  
+353 (0) 91 703 733